

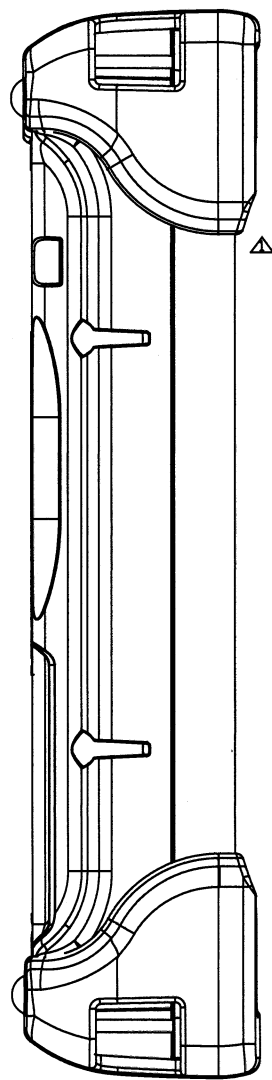

DRAWING NO.
異図

8	9	10	11
記号 MARK	座標 COORDINATES	日付 DATE	変更記事 ALTERATIVE ARTICLE
△	C-3, C-6, D-10	2019/03/05	上ケースをかさ上げ、電池室+ビス
			担当 NAME 榎本
			承認 APPROVED A版

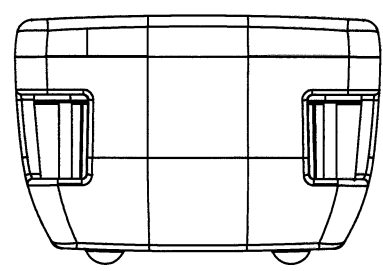
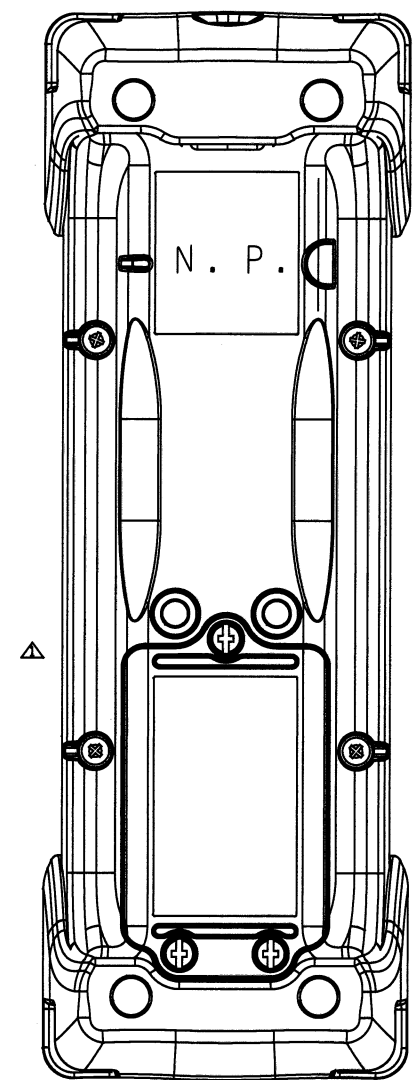
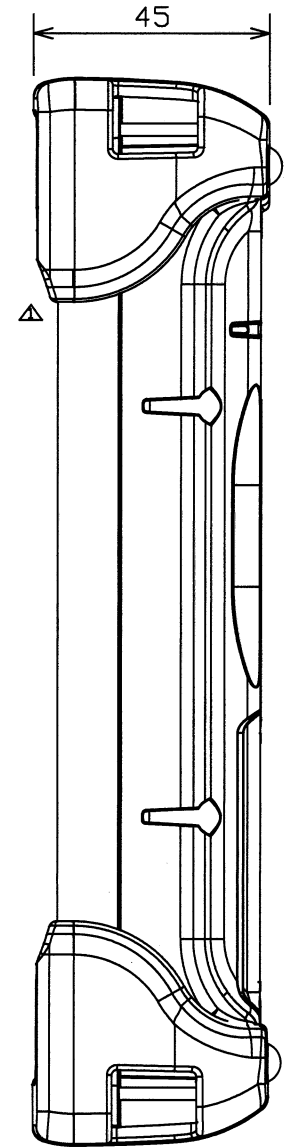
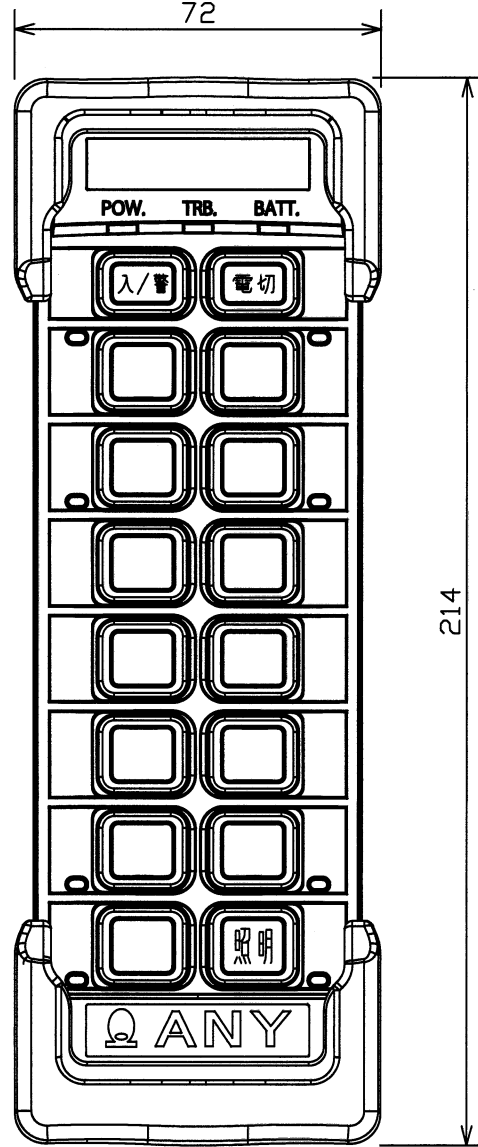
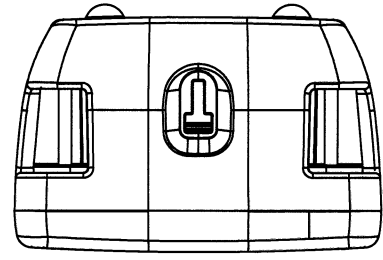

A
B
C
D
E
F
G

9
8
7
6
5
4
3
2
1
PAGE

記事 NOTE	第3角法 3RD ANGLE PROJECTION	写図 DRAWN: . . .	 株式会社工二一 ANY&CO., LTD.
材料 MATERIAL	単位 UNITS MM	製図 DESIGNED: T. Enomoto	
処理 TREATMENT	数量 PIECE	尺度 SCALE	名称 TITLE
仕上 FINISH	1 SET	1 / 1.5	無線遠隔制御装置 FTH160VZ/WZ 外観図
		承認 APPROVED: 20.3.5	図番 DRAWING NO. Z0001-370A