

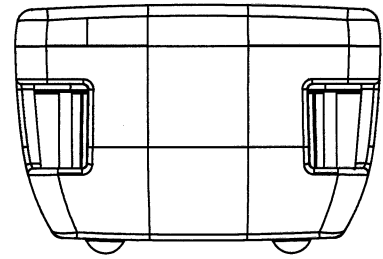

DRAWING NO.
異図

8	9	10	11
記号 MARK	座標 COORDINATES	日付 DATE	変更記事 ALTERATIVE ARTICLE
△	G-3, C-6, D-10	2019/03/05	上ケースをかさ上げ、電池室+ビス
			担当 NAME 榎本
			承認 APPROVED A版

A
B
C
D
E
F
G

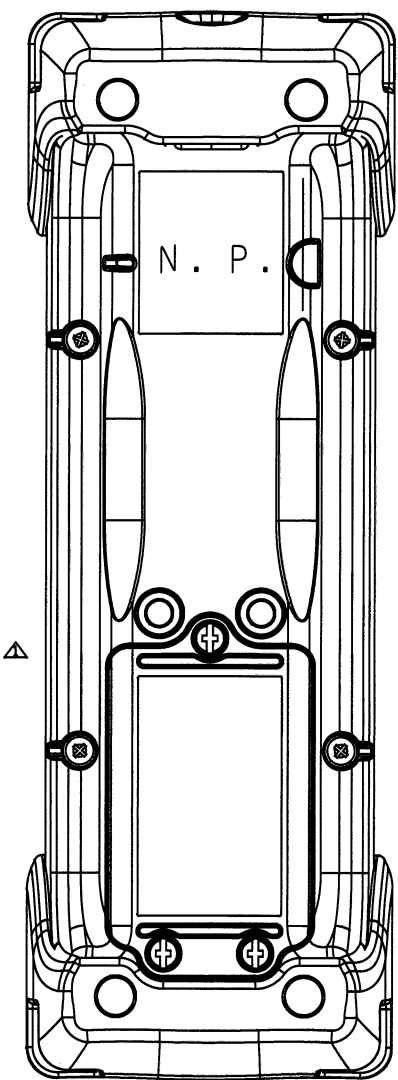
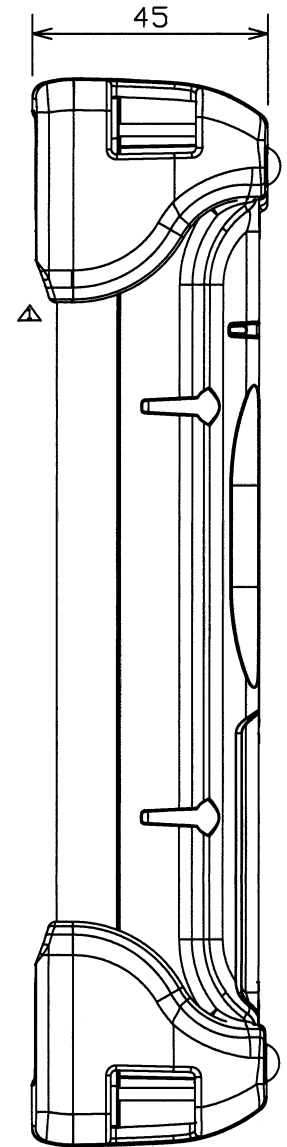
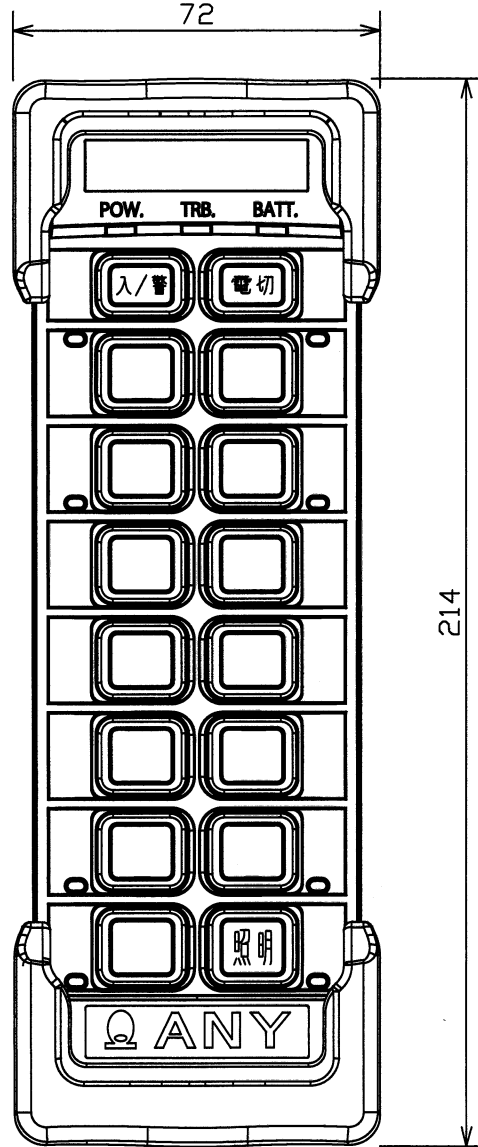
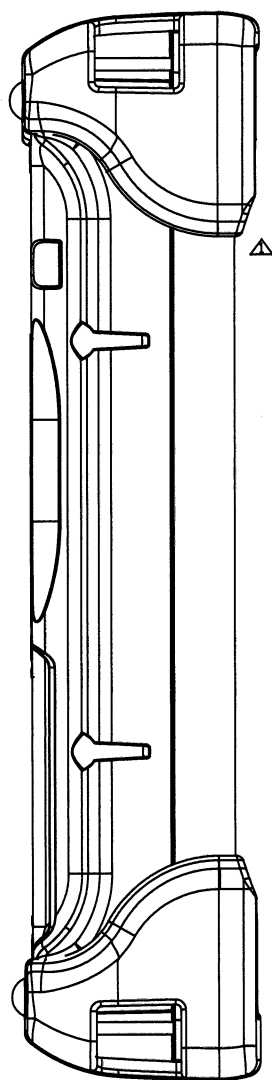
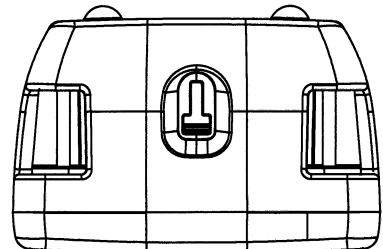

9
8
7
6
5
4
3
2
1
PAGE

記事 NOTE	上ケース色：黄 下ケース色：青	第3角法 3RD ANGLE PROJECTION	写図 DRAWN: . . . 製図 T. Enomoto DESIGNED: '20. 3. 5	 株式会社 工二一 ANY & CO., LTD.
材料 MATERIAL		単位 UNITS MM	設計 PLANNED: . . .	
処理 TREATMENT	数量 PIECE	尺度 SCALE	検図 山崎 CHECKED: '20. 3. 5	名称 TITLE
仕上 FINISH	1台 1 SET	1 / 1.5	承認 澤城 APPROVED: '20. 3. 5	無線遠隔制御装置 GTH160VZ/WZ 外観図
				図番 DRAWING NO.
				Z0001-418A